

Datablad | Artikelnummer: 221-415

Fjedersamlemuffe med vippepal; til alle slags ledere; maks. 4 mm²; 5-leder; med vippepaler; gennemsigtigt hus; Omgivende temperatur: maks. 85 °C (T85); 4,00 mm²; transparent



<https://www.wago.com/221-415>



Farve: transparent



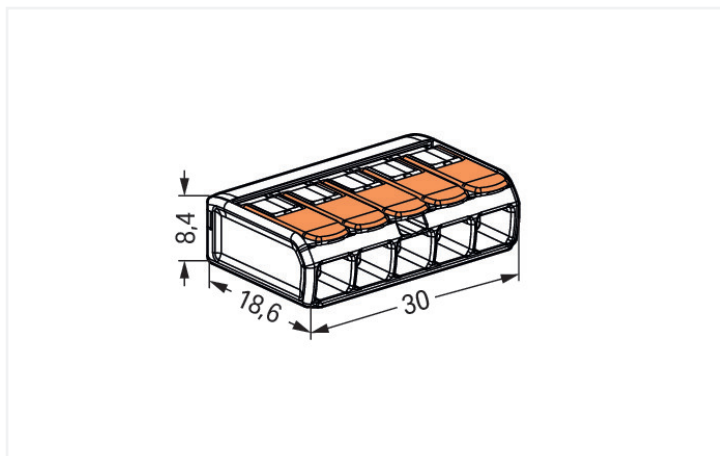

Dimensions in mm

Dine fordele:

Bemærkninger

Sikkerhedsoplysninger

i jordede strømledninger

Elektriske data

Mærkninger iht.	EN 60664		
Overvoltage category	III	III	II
Pollution degree	3	2	2
Mærkespænding	-	-	450 V
Mærkepulsspænding	-	-	4 kV
Mærkestrøm	-	-	32 A

Godkendelser iht.	UL 486C		
Use group	B	C	D
Mærkespænding	-	600 V	-
Mærkestrøm	-	20 A	-

Tilslutningsdata

Tilslutningspunkter	5
Antal potentialer i alt	1

Tilslutning 1	
Tilslutningsteknologi	CAGE CLAMP®
Aktiveringstype	Vippepal
Anvendbare ledematerialer	Kobber
Nominel ledertværsnit	4 mm ² / 12 AWG
Solid leder	0,2 ... 4 mm ² / 24 ... 12 AWG
Trådet leder	0,2 ... 4 mm ² / 24 ... 12 AWG
Fleksibel leder	0,14 ... 4 mm ² / 24 ... 12 AWG
Afisoleringslængde	11 mm / 0.43 tommer
Fortrådningsretning	Sidefortrådning

Fysiske data

Bredde	30 mm / 1.181 tommer
Højde	8,4 mm / 0.331 tommer
Dybde	18,8 mm / 0.732 tommer

Materialedata

Note (materiel data)	Oplysninger om materialespecifikationer kan findes her/a
Farve	transparent
Isolations materiale	Polykarbonat (PC)
Brandbarhedsklasse i henhold til UL94	V2
Brand last	0.089 MJ
Aktuator farve	orange
Vægt	4 g

Miljø krav

Omgivende temperatur (drift)	+85 °C
Vedvarende driftstemperatur	105 °C
Temperatur opmærkning iht. EN 60998	T85

Kommercielle data

Product Group	7 (Push Wire Conn.)
eCl@ss 10.0	27-14-11-04
eCl@ss 9.0	27-14-11-04
ETIM 8.0	EC000446
ETIM 7.0	EC000446
PU (SPU)	250 (25) Stykke
Emballage type	Box
Oprindelsesland	DE
GTIN	4055143234658
Told tarifnummer	85369010000

Produktets miljøoverholdelse

RoHS Compliance Status	Compliant, No Exemption
------------------------	-------------------------

Godkendelser/certifikater

Generelle godkendelser



Godkendelse {0}	Standard	Certifikatnavn
CCA DEKRA Certification B.V.	EN 60998	NTR NL-7990
cULus_Listed_667F Underwriters Laboratories Inc.	UL 486C	E69654
ENEC 05 DEKRA Certification B.V.	EN 60669, EN 60998	71-127529
UL_Listed_64KA UL International Germany GmbH	UL 467	E201573

Overensstemmelseserklæringer og fabrikantens erklæringer

Godkendelse {0}	Standard	Certifikatnavn
EU-Declaration of Conformity WAGO GmbH & Co. KG	-	-
UK-Declaration of Conformity WAGO GmbH & Co. KG	-	-

Godkendelser til marineapplikationer



Godkendelse {0}	Standard	Certifikatnavn
ABS American Bureau of Shipping	-	18-HG1755093-PDA
DNV GL Det Norske Veritas, Germanischer Lloyd	EN 60998	TAE000015T
LR Lloyds Register	EN 60998	LR22207029TA

Downloads

Environmental Product Compliance

Compliance Search

Environmental Product
Compliance 221-415

Documentation

Bid Text

221-415	19.02.2019	xml 3.43 KB	
---------	------------	----------------	---

221-415	23.01.2019	docx 15.31 KB	
---------	------------	------------------	---

ausschreiben.de
221-415

CAD/CAE-Data

CAD data

2D/3D Models 221-415



CAE data

EPLAN Data Portal
221-415

ZUKEN Portal 221-415



1 Kompatible produkter

1.1 Valgfrit tilbehør

1.1.1 Generelt tilbehør

1.1.1.1 Fugtbeskyttelse

**Bestill.nr.: 207-1332**Gelbox; Afdeling; til kabler; med gel; Serie 221, 2 x 73; max. 4 mm²-stikforbindelser; uden fjedersamlemuffer; Størrelse 2; grå

1.1.1.2 Tomme huse

**Bestill.nr.: 207-4301**Forgreningsboks; Afdeling; til flerlederka-
bler; Serie 221; max. 4 mm²-stikforbin-
delse; uden fjedersamlemuffer; hvid

1.1.2 Laske

1.1.2.1 Laske



Bestill.nr.: 221-941/000-006

Laske; for conductor entry; 2-vejs; isole-
ret; blå



Bestill.nr.: 221-942/000-006

Laske; for conductor entry; 2-vejs; isole-
ret; blå



Bestill.nr.: 221-941

Laske; for conductor entry; 2-vejs; isole-
ret; mørkegrå



Bestill.nr.: 221-942

Laske; for conductor entry; 2-vejs; isole-
ret; mørkegrå

1.1.3 Monteringsadapter

1.1.3.1 Monteringstilbehør



Bestill.nr.: 221-515

Fastgørelsesadapter; til 5-lederklemmer;
WAGO 221 – 4 mm²; med snap in-monte-
ringsfod til horisontal montering; hvid



Bestill.nr.: 221-515/000-004

Fastgørelsesadapter; til 5-lederklemmer;
WAGO 221 – 4 mm²; med snap in-monte-
ringsfod til horisontal montering; sort



Bestill.nr.: 221-525

Fastgørelsesadapter; til 5-lederklemmer;
WAGO 221 – 4 mm²; med snap in-monte-
ringsfod til vertikal montering; hvid



Bestill.nr.: 221-525/000-004

Fastgørelsesadapter; til 5-lederklemmer;
WAGO 221 – 4 mm²; med snap in-monte-
ringsfod til vertikal montering; sort



Bestill.nr.: 221-505

Fastgørelsesadapter; til 5-lederklemmer;
WAGO 221 – 4 mm²; til skruemontering;
hvid



Bestill.nr.: 221-505/000-004

Fastgørelsesadapter; til 5-lederklemmer;
WAGO 221 – 4 mm²; til skruemontering;
sort



Bestill.nr.: 221-500/000-006

Fastgørelsesadapter; WAGO 221 – 4
mm²; til DIN 35-skinne monterings/skrue-
mont.; blå



Bestill.nr.: 221-500/000-053

Fastgørelsesadapter; WAGO 221 – 4 mm²;
til DIN 35-skinne monterings/skrue mont.;
mørkegrå-gul



Bestill.nr.: 221-500

Fastgørelsesadapter; WAGO 221 – 4 mm²;
til DIN 35-skinne monterings/skrue mont.;
orange

Installeringsbemærkninger:

Lederafslutning

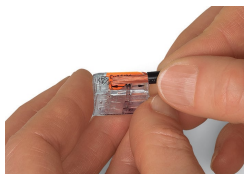

Strip conductor to 11 mm (0.43 inch).

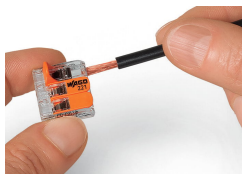

Pull up an orange lever to open the clamp-
ing unit.

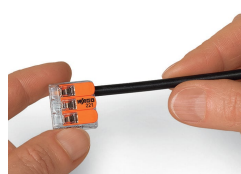

Then insert the conductor and push the
lever back down, flush with the connector
housing.



**Compact, lever-operated splicing
connectors:**

Tool-free connection of fine-stranded
conductors from 0.14 ... 4 mm², as well as
solid or stranded conductors from 0.2 ... 4
mm² (24 ... 12 AWG).

Safety:

The lever's specially designed rest posi-
tion reliably prevents accidental unclamp-
ing of a connected conductor.

Application safety, for any type of con-
ductor (solid, stranded, fine-stranded), is
confirmed by approvals like ENEC or UL.

Applikation:

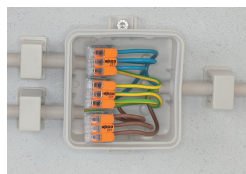

Wiring fine-stranded conductors in junction boxes.



Custom low-voltage lighting system



Lighting distribution in a ceiling canopy



Pendant light connection in a suspended ceiling